

Welcome to EE2S31 Signal Processing



Lecturers



Alle-Jan van der Veen
(A.J.vanderVeen@tudelft.nl)



Geethu Joseph
(G.Joseph@tudelft.nl)



Borbala Hunyadi
(B.Hunyadi@tudelft.nl)

Signal Processing Systems (SPS) group, Department of Microelectronics

Signal Processing

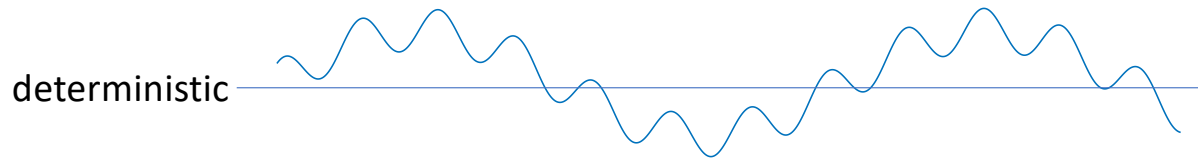

➡ Spectrum (DFT / FFT)

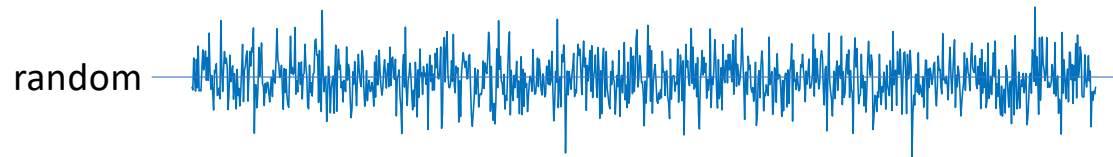

➡ Spectrum ?

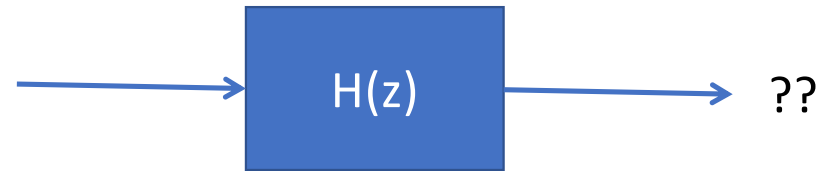
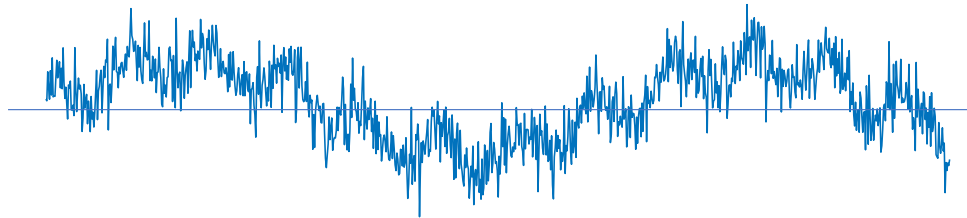

Overview of signal processing

- **Techniques and Methods**

- Sampling and reconstruction (compressive sensing)
- Statistical signal processing (parameter estimation, detection), machine learning
- Analytical techniques (e.g. linear algebra, optimization)
- Distributed processing, graph signal processing
- DFT, filters, filter banks
- Adaptive filters, neural networks
- DSP hardware, fast algorithms/architectures

- **Applications**

- Communication, radar, sonar, sensor arrays (multichannel signal processing), information theory
- Speech and audio processing
- Image, video and multimedia processing
- Biomedical/bioinformatics

Example: telecom

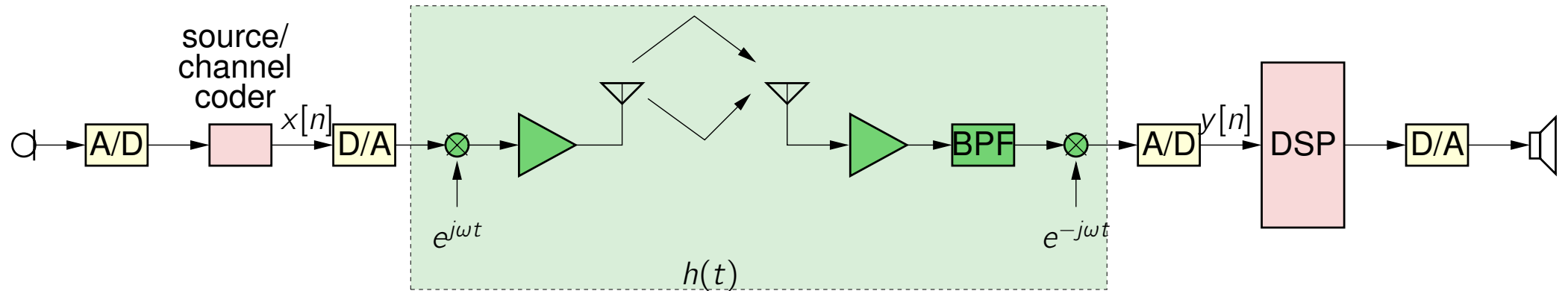

INFORMATION THEORY
SIGNAL PROCESSING

ELECTRONICS ELECTRO- MAGNETISM
TELECOM

channel inversion (equalization)
parameter estimation
detection
SIGNAL PROCESSING

Context

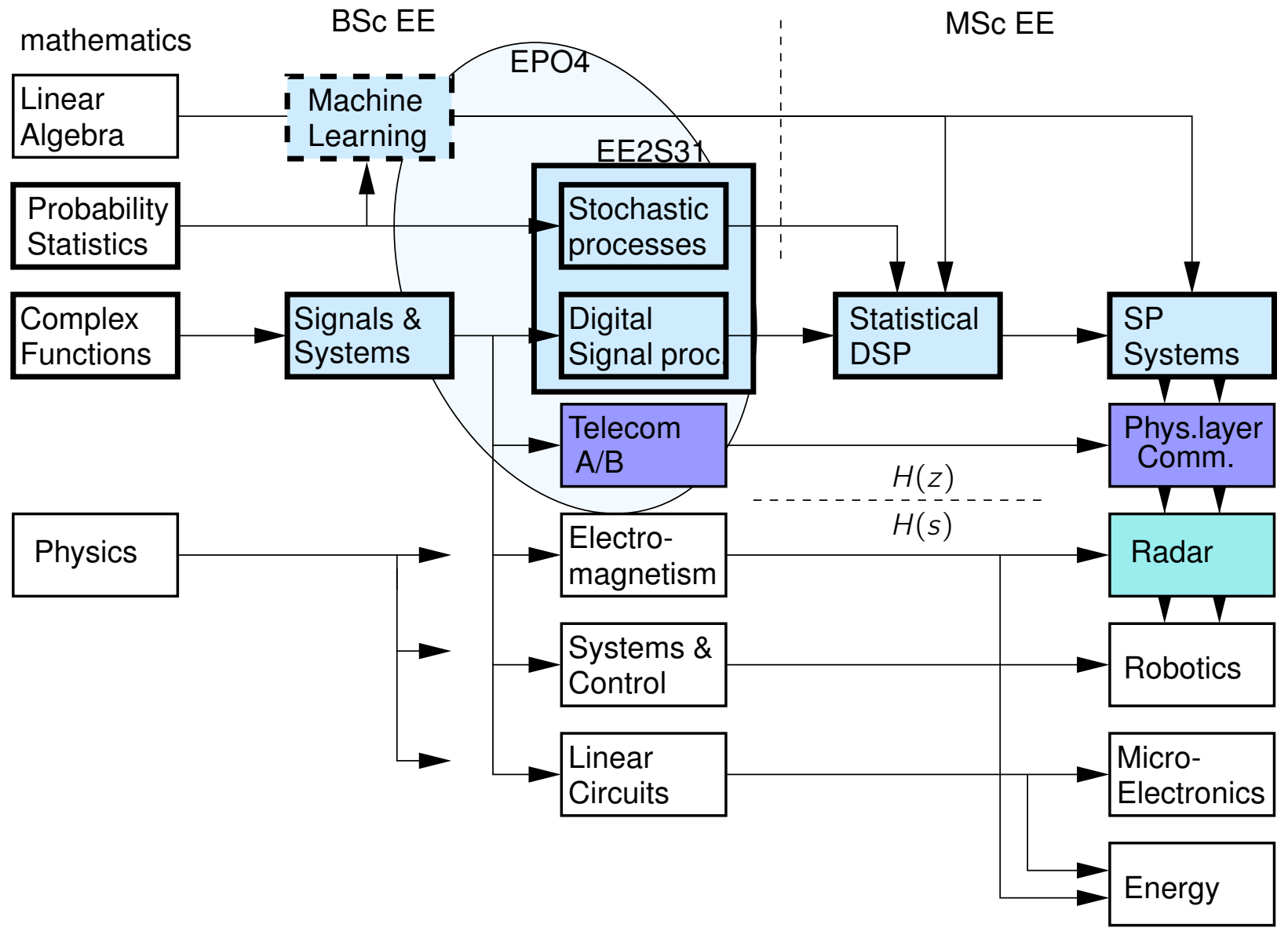

Organization

- Lectures (2 or 3 per week), recorded on Collegerama
- Self-study:
 - Book
 - Recorded video lectures (Collegerama)
 - Exercises, past exams (Brightspace)

Two independent tracks:

- Stochastic Processes (SP)
- Digital Signal Processing (DSP)

Where to find information

- Website:
 - <http://sps.ewi.tudelft.nl/Education/courses/ee2s31/>
 - Overall schedule, book chapters, links to Collegerama recordings from 2022

- Brightspace:
 - Announcements, discussion forum
 - Detailed weekly schedule including links to self-study materials

Exam

Dates (2024):

- Part 1: Mid-term on 22 May (week 5)
- Part 2: Final exam on 28 June (week 10)

Content and evaluation:

- Both parts will consist of exercises from SP and DSP (50/50)
- The end result is the average of the mid-term and final exam
- The resit consists of both parts (i.e., partial results are not valid anymore)

Format:

- Written exam
- Closed-book, you can bring a 1 page cheat sheet (handwritten)

- Stochastic Processes:

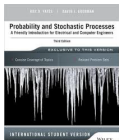

R.D. Yates and D.J. Goodman, Probability and Stochastic Processes: A Friendly Introduction for Electrical and Computer Engineers

- Digital Signal Processing:

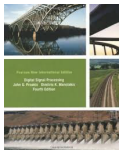

J.G. Proakis and D.G. Manolakis. Digital Signal Processing. Pearson New International Edition